

# FlexStyle® Cassette Clutch

Manual, clutch-operated cassette shade

## INSTRUCTIONS

### INSTALLATION & OPERATION

Overview - **Components** (Square Cassette, Elliptical Style Hem Bar shown)

**FSTYL CASS CLN**

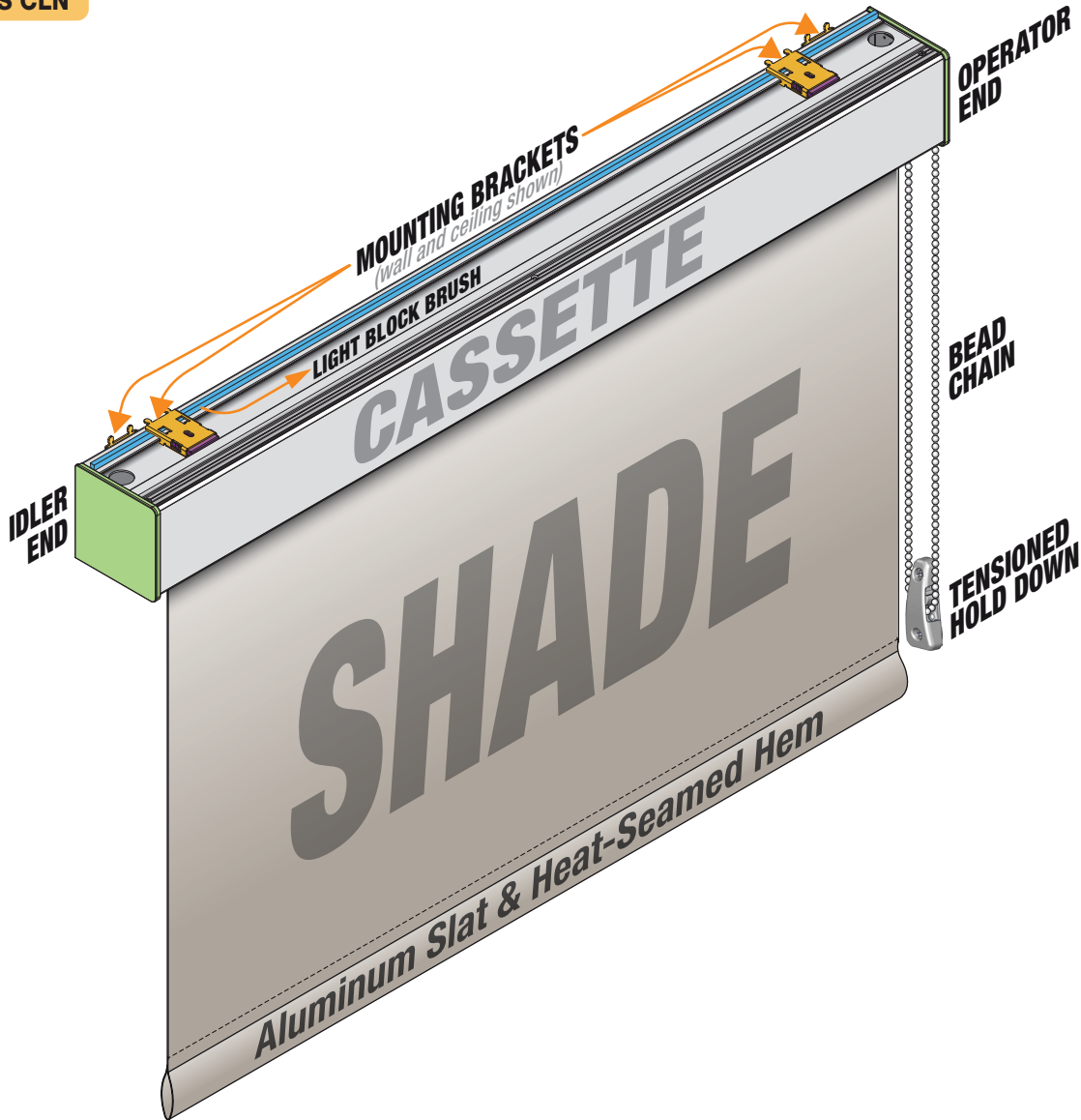

#### TOOLS REQUIRED



PENCIL

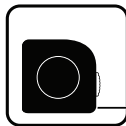

TAPE MEASURE

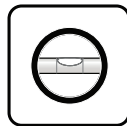

LEVEL



POWER DRILL



PLIERS

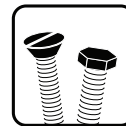

HARDWARE (by others)

#### ⚠ CAUTION ⚠

Read and understand  
all warnings before  
beginning installation.

#### Contents

Overview - <b>Components</b> .....	1	Section 3 - <b>Ceiling Mounting Shade</b> .....	4
PLEASE READ - <b>Important Safety &amp; Installation Information</b> .....	2	Section 4 - <b>Tensioned Hold Down</b> .....	5
PLEASE READ - <b>Field Adjustments, Cleaning and Maintenance</b> .....	2	Section 5 - <b>Cassette Dimensions</b> .....	5
Section 1 - <b>Installing Mounting Brackets</b> .....	3	Section 6 - <b>Shade Dimensions</b> .....	6
Section 2 - <b>Wall Mounting Shade</b> .....	4		

If you have any difficulties installing or servicing your Clutch-Operated FlexStyle Cassette, call your dealer or Draper, Inc.

## PLEASE READ - Important Installation Information

### ⚠ Caution:

1. Inspect all boxes to make sure you have received the proper shades and parts. Controls may be shipped separately, or in same carton as shades.
2. Open cartons lengthwise.
3. Before mounting shades, verify measurements on label provided with shade, and ensure unit is installed at correct width.
4. All hardware must be installed level. Shades must be level and square.
5. **Read the following installation guidelines thoroughly and follow them carefully. Failure to do so may cause product to fall or otherwise fail, and invalidates warranty.**
6. **Installer is responsible for selecting mounting hardware appropriate for site conditions.**

## PLEASE READ - Safety Information

### Important Safety Information



### Important Safety Information

**Improper installation and use of the FlexStyle® Cassette Clutch can result in serious injury or death. Primarily, injuries can occur if the unit falls due to imprecise installation, mishandling of the unit during installation, or installation on an insufficient wall or ceiling structure. Please use extreme care.**

1. Please read the following installation guidelines thoroughly and follow them carefully. Failure to do so may cause product to fall or otherwise fail, and could result in serious injury.
2. Installation and calibration of the unit should only be performed by an authorized, qualified, and experienced professional.
3. Do not affix the unit to wall or ceilings that have inadequate strength to permanently hold the unit during use. It is the owner's and installer's responsibility to confirm the wall or ceiling to which the unit attaches is sufficient to permanently hold the weight and stress loads of the unit at all times. Draper, Inc., is not responsible for improper installation, application, testing, or workmanship related to the product at place of installation.
4. It is the installer's responsibility to make sure appropriate fasteners are used for mounting.
5. All hardware must be installed level. Unit must be level and square.
6. Never leave the area while operating the unit during installation, maintenance, or normal operation, unless it is secure and safe.
7. Before testing or operation, carefully inspect the entire area and path of the shade and areas underneath the shade to be sure no persons or objects are in the area.
8. During testing or operation, carefully watch the surrounding area for any potential safety concerns including nearby persons or objects.
9. After installation, the entire system, including all sensors, should be carefully tested to ensure safe and normal operation. Extreme care should be taken during testing to remain clear of moving parts to avoid possible injury.
10. Operation of unit should be performed only by authorized and qualified personnel, who have been trained in the safe and effective operation of the unit and understand its safety features.
11. The safety features of the unit should never be disabled, bypassed, or overridden. The system should not be operated until all safety features are properly and completely installed, calibrated, and tested.
12. Unit may need to comply with local, state, or district rules and regulations, in particular when installed in schools. All applicable rules and regulations should be reviewed before installation and use.
13. Failure to precisely follow installation guidelines invalidates all warranties.
14. Custom products/installations may not be reflected in this manual. Call Draper®, Inc., if you have questions about the installation of custom products or any questions about your installation.

### Child Safety Information

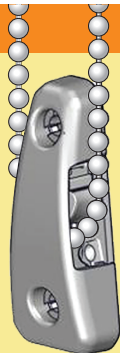

To comply with Child Safety Standard ANSI/WCMA A100.1-2022, this product ships with a tensioning device attached to the bead chain. Incorrect installation partially disables the product. When properly fastened to mounting surface, the pre-installed Tensioned Hold Down device for clutch-operated units prevents creation of a hazardous loop by maintaining tension on the bead chain.

**⚠ WARNING**  
**⚠ ADVERTENCIA**

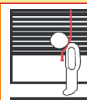

**Window Blind Cord Can STRANGLE Your Child.**  
Keep all cords out of children's reach. Shorten cords to prevent reach. Move crib and furniture away - Children can climb furniture to reach cords.  
**La cuerda de la persiana puede ESTRANGULAR su niño.**  
Mantenga las cuerdas fuera del alcance de los niños. Acorte las cuerdas para evitar el alcance. Mueva la cuna y los muebles - Los niños pueden subir los muebles para alcanzar cuerdas.

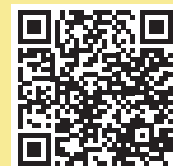

Scan for more information, including short videos on correctly installing the tensioning device, or go to [draperinc.com/windowshades/childsafety](http://draperinc.com/windowshades/childsafety).

### Before Beginning Installation

1. Look for any job site conditions that could interfere with installation or operation of the system.
2. Read carefully and be sure to understand all installation instructions and all related operations manuals. These instructions are intended to serve as a guide for the installer and owner. They should be followed closely and combined with the expertise of experienced qualified installers. Draper, Inc., is not responsible for improper installation, application, testing, or workmanship related to the product at place of installation. Please retain all instructions for future use.
3. Open cartons lengthwise.
4. Locate and lay out all pieces.
5. Inspect all boxes to make sure you have received the proper shade and parts. Controls may be shipped separately, or in same carton as shade.
6. If you have any difficulties with installing, servicing, or operating your shade, call your dealer or Draper, Inc., 765-987-7999.

### PLEASE READ - Field Adjustments

Each Draper Shade is tested to ensure proper operation. Even with this testing, some field adjustments may be needed for telescoping.

If the shade is telescoping, place a piece of shimming fabric into the fabric roll when the shade is deployed on the side that the fabric will be drawn toward. For example: if the fabric is tracking to the left, place the shimming fabric on the right side.

### PLEASE READ - Cleaning and Maintenance

Window covering products manufactured by Draper, when properly installed, should require no operational maintenance or lubrication.

Most standard Draper fabrics may be cleaned at the window by vacuuming with a soft brush attachment. They also may be cleaned by using a sponge or soft cloth and mild solution of warm soapy water. A mild dishwashing liquid is recommended. A clean dry cloth is recommended for the metal finish.

**Please Note:** Exceptions are GreenScreen Evolve®, GreenScreen Revive®, and Phifer® SW7000 fabrics, which must be cleaned with a dry art sponge. (GreenScreen Revive® and GreenScreen Evolve® are registered trademarks of Mermet® USA. SheerWeave® is a registered trademark of Phifer® Incorporated.)

## Section 1 - Installing Mounting Brackets

**IMPORTANT:** Mounting Brackets must be installed parallel, plumb, and square, with a tolerance of +/- 1/8" (3mm). Verify unit measurements and ensure unit will fit in the desired location.

**Please Note:** Installer is responsible for selecting mounting hardware appropriate for site conditions.

1. Mark wall, jamb, or ceiling for placement of mounting brackets. (*Idler Bracket shown.*)

**Please Note:**

Brackets should be installed far enough from the ceiling (*wall mount*) or wall (*ceiling mount*) that the tabs on top of the brackets fit. Tabs may then be removed (*if desired*).

**Please Note:**

Brackets should be installed no more than 5" (127mm) in from ends of Cassette Assembly. If provided, center bracket should be mounted in center of the case.

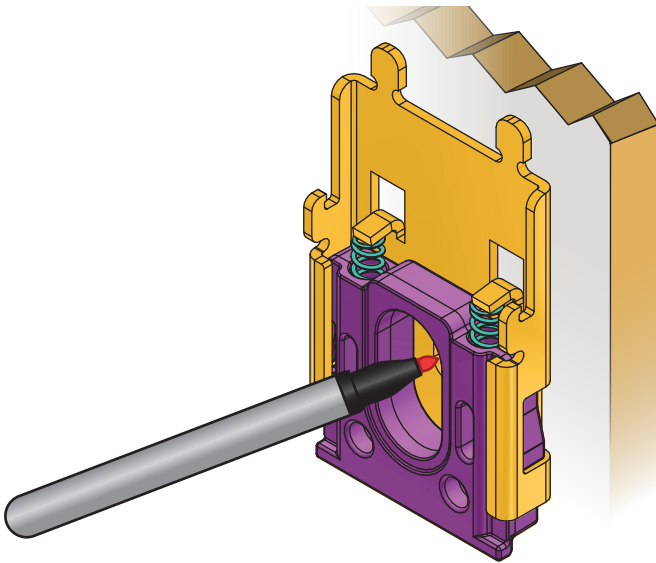

2. Drill small starter hole in mounting surface (*if necessary*).

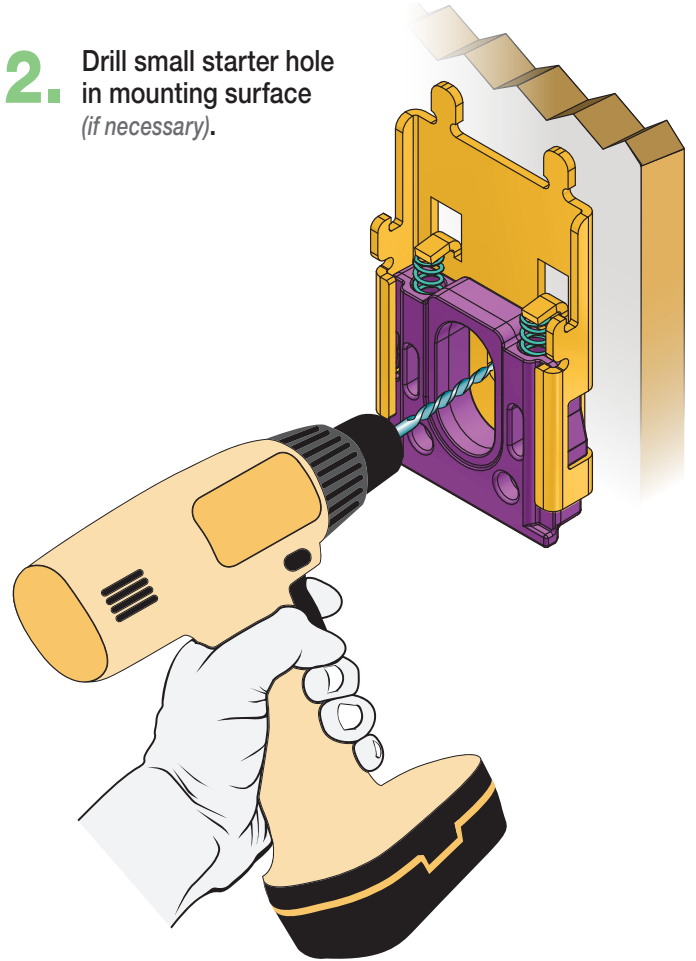

3. Attach brackets using appropriate fasteners (*by others*) for mounting surface.

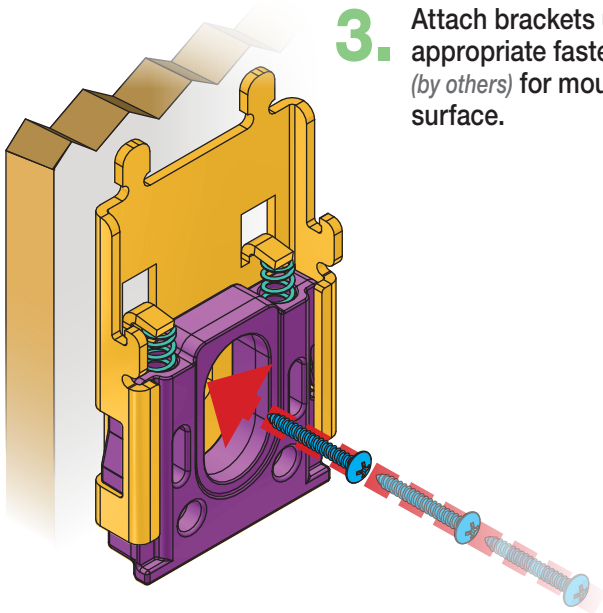

4. If tabs are visible above the window, they may be removed (*if desired*).

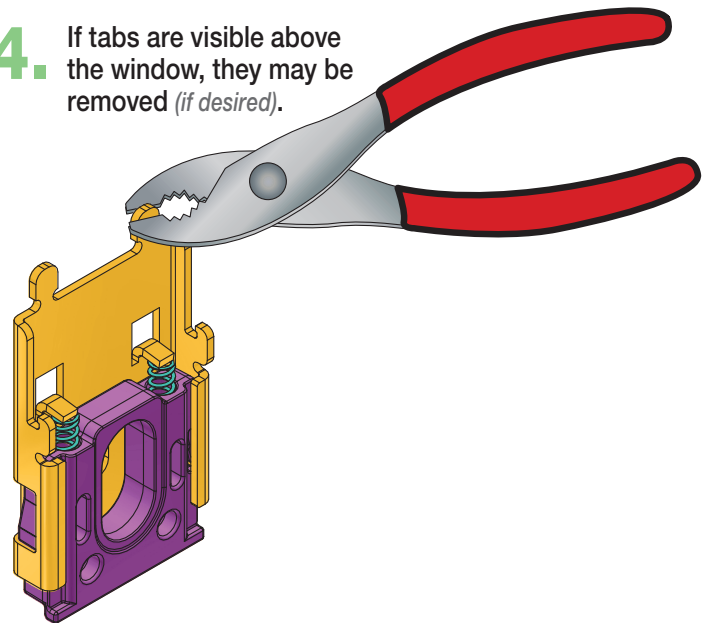

## Section 2 - Wall Mounting Shade (Curved Cassette with open bottom shown)

**Please Note:** Brackets should be installed no more than 5" (127mm) in from ends of Cassette Assembly. Install any remaining brackets evenly between the outermost brackets.

**1.** Lift Cassette Assembly into place and align between the Mounting Brackets.

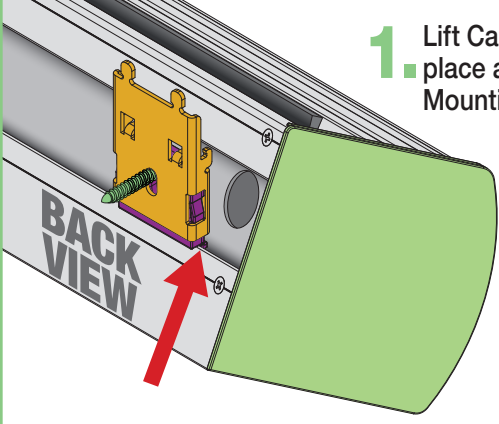

**2.** Tilt Cassette forward and depress spring-loaded tabs on the Mounting Brackets by pushing up with the bottom of the channel on back of the Cassette Assembly.

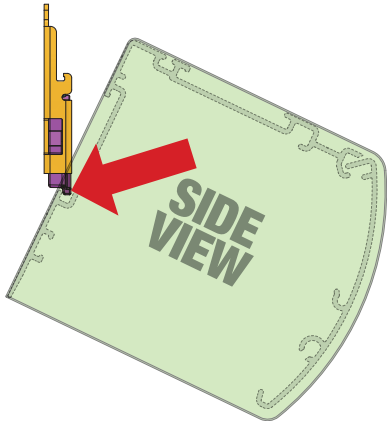

**3.** Insert the spring-loaded tabs into the bottom channel on back of the Cassette Assembly.

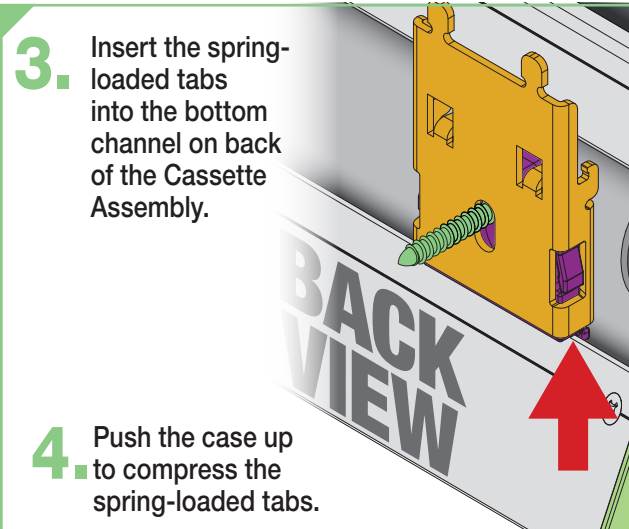

**4.** Push the case up to compress the spring-loaded tabs.

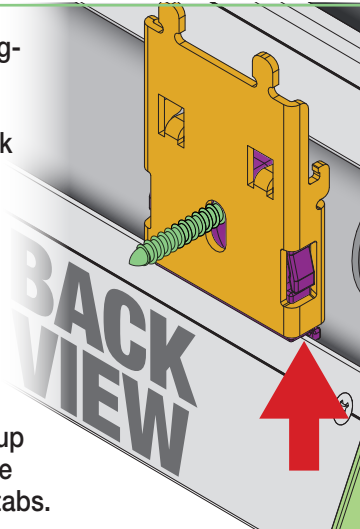

**5.** Rotate Cassette into position onto the top hooks on the Mounting Brackets.

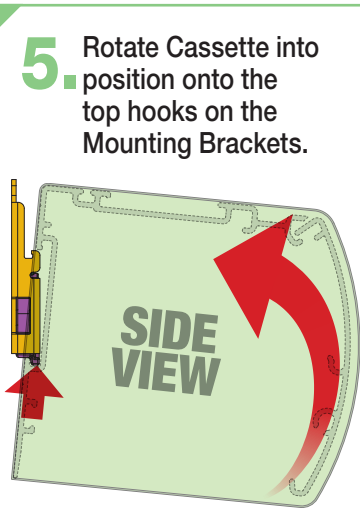

**6.** Release spring-loaded tab into the top channel on back of the Cassette Assembly.

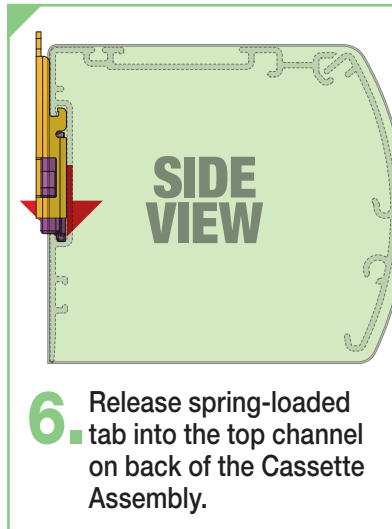

## Section 3 - Ceiling Mounting Shade (Curved Cassette with open bottom shown)

**Please Note:** Brackets should be installed no more than 5" (127mm) in from ends of Cassette Assembly. Install any remaining brackets evenly between the outermost brackets.

**1.** Lift Cassette Assembly into place and align between the Mounting Brackets.

**2.** Tilt Cassette up and insert the spring-loaded tabs into the top channel on the Cassette Assembly.

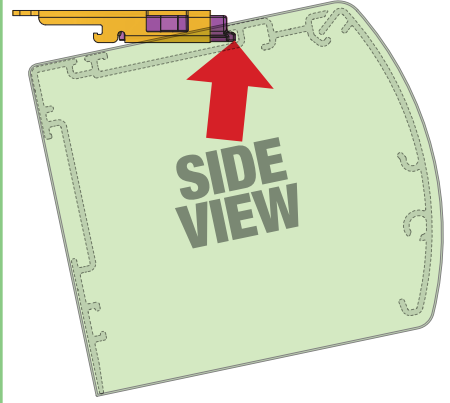

**3.** Push case back to compress the spring-loaded tabs on the Mounting Brackets.

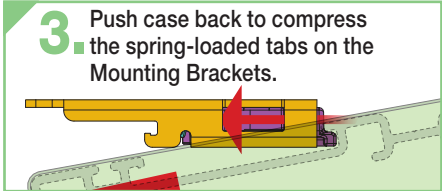

**4.** Rotate Cassette up into position onto top hooks on the Mounting Brackets.

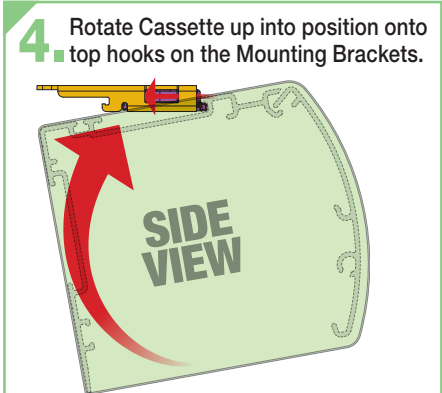

**5.** Release spring-loaded tab and top hooks into the top channel on top of the Cassette Assembly.

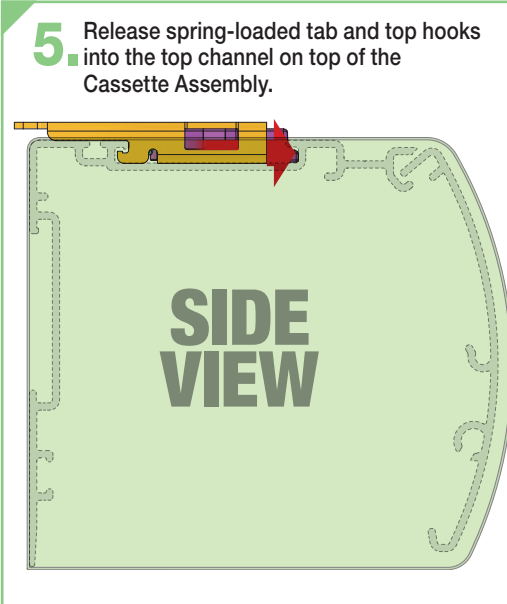

## Section 4 - Tensioned Hold Down (Must be installed to make shade fully operable.)

**Please Note:** Screws provided are not suitable for all mounting surfaces. The installer is responsible for secure mounting using appropriate hardware for the site conditions. Consult with contractors and builders as needed.

- 1.** Lift bead chain out of bead locking groove and slide tensioned hold down to bottom of chain loop.
- 2.** Hold tensioned hold down in one hand while pulling plunger away from bead chain with other hand.
- 3.** Pull tensioned hold down until bead chain is fully tensioned and move tension device up approx. 1/8" (3mm)
- 4.** Mark screw hole locations with a pencil.

**INSIDE MOUNT**

If mounting directly onto the surface, pre-drill screw holes and then install the tensioned hold down using the 2 large screws provided.

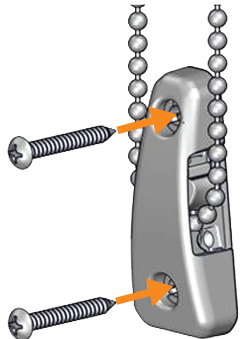

**SIDE OR INSIDE MOUNT**

**A.** Align mounting bracket sight holes with pencil marks and attach bracket to mounting surface.

**B.** Press tensioned hold down onto mounting bracket posts and carefully install device using the two smaller provided screws with appropriate screwdriver.

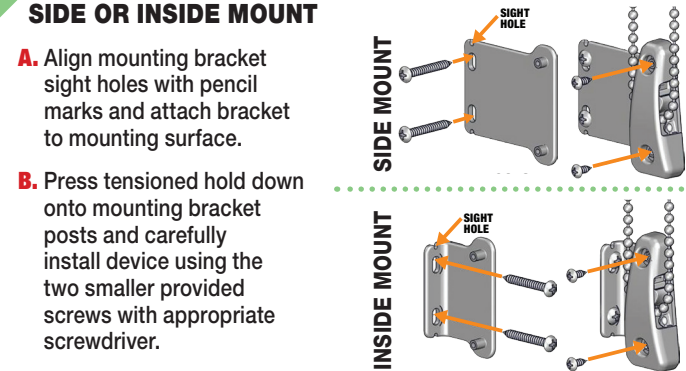

**FLOOR MOUNT**

**A.** Securely fix floor mount bracket to surface.

**B.** Assemble tensioned hold down & chain.

**C.** Adjust bead chain so that plunger is 1/8" (3mm) below top position.

**D.** Adjust chain length by removing and then reassembling stop balls.

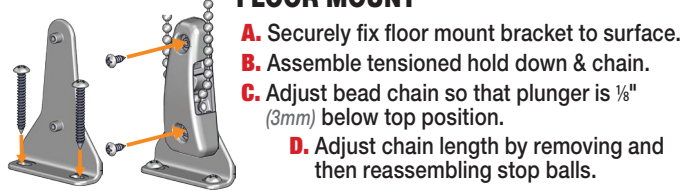

## Section 5 - Cassette Dimensions

**SQUARE CASSETTE**  
(no Mounting Brackets)

NOTE: Minimum depth of installation is 1 3/4" (44mm).

3 7/8" (98mm)

3 7/8" (98mm)

**SQUARE CASSETTE**  
(Ceiling Mounting Brackets)

NOTE: Minimum depth of installation is 1 3/4" (44mm).

4" (102mm)

4" (102mm)

**SQUARE CASSETTE**  
(Wall Mounting Brackets)

NOTE: Minimum depth of installation is 1 3/4" (44mm).

4" (102mm)

4" (102mm)

**CURVED CASSETTE**  
(no Mounting Brackets)

NOTE: Minimum depth of installation is 1 3/4" (44mm).

4 3/8" (111mm)

3 7/8" (98mm)

**CURVED CASSETTE**  
(Ceiling Mounting Brackets)

NOTE: Minimum depth of installation is 1 3/4" (44mm).

4 1/2" (114mm)

4" (102mm)

**CURVED CASSETTE**  
(Wall Mounting Brackets)

NOTE: Minimum depth of installation is 1 3/4" (44mm).

4 1/2" (114mm)

4" (102mm)

## Section 6 - Shade Dimensions

