

# StyleLine

Fixed screen with bezel trim or borderless option

## SUBMITTAL

### TECHNICAL INFO

#### Specifications

\_\_\_\_\_ Permanently mounted fixed frame projection screens, size \_\_\_\_\_ h. x \_\_\_\_\_ w. (viewing area), designed for wall mounting. Sub Frame shall be .065 inch thick 6063 aluminum. Frame equipped with mounting flange to interface with Z-Clip wall mounting brackets. 1/2" (13 mm) back lip on frame to accept LED light strip (by others). Base trim frame extrusions provide for up to 1 3/8" (35 mm) of horizontal and vertical surface tension adjustability. Screen viewing surface is 2 3/8" (56mm) from mounting surface.

#### FRAME OPTIONS:

**Bezel Frame:** [5/8" (16 mm)] [3 3/8" (81 mm)] black Vel-Tex covered extruded aluminum bezel trim frame visible from the front.

**Borderless Frame:** Sub frame shall be completely hidden by the projection viewing surface.

**Viewing Surface:** To attach to frame using using a continuous hook & loop attachment. Matt White XT1000VB and Grey XH600V viewing surfaces are certified to GREENGUARD standards for low chemical emissions into indoor air during product usage. For more information, visit [ul.com/gg](http://ul.com/gg).



#### DOWNLOADABLE 3-PART SPECIFICATIONS:

Available at [www.draperinc.com](http://www.draperinc.com)

**Please note:** Dimensions of hardware at manufacturer's discretion.

#### Select Image Size, Frame Edge Option and Quantity.

16:10 Format						
Nominal Diagonal	Image Size	Overall H" x W", Borderless Qty.	Overall H" x W", 5/8" Vel-Tex Bezel Qty.	Overall H" x W", 3 3/8" Vel-Tex Bezel Qty.		
94"	50" x 80"	50" x 80"	51 1/4" x 81 1/4"	56 3/8" x 86 3/8"		
109"	57 1/2" x 92"	57 1/2" x 92"	58 3/4" x 93 1/4"	63 7/8" x 98 3/8"		
113"	60" x 96"	60" x 96"	61 1/4" x 97 1/4"	66 3/8" x 102 3/8"		
123"	65" x 104"	65" x 104"	66 3/4" x 105 1/4"	71 7/8" x 110 3/8"		
137"	72 1/2" x 116"	72 1/2" x 116"	73 3/4" x 117 1/4"	78 3/8" x 122 3/8"		
165"	87 1/2" x 140"	87 1/2" x 140"	88 3/4" x 141 1/4"	93 7/8" x 146 3/8"		
16:9 HDTV Format						
Nominal Diagonal	Image Size	Overall H" x W", Borderless Qty.	Overall H" x W", 5/8" Vel-Tex Bezel Qty.	Overall H" x W", 3 3/8" Vel-Tex Bezel Qty.		
92"	45" x 80"	45" x 80"	46 1/4" x 81 1/4"	51 3/8" x 86 3/8"		
100"	49" x 87"	49" x 87"	50 1/4" x 88 1/4"	55 3/8" x 93 3/8"		
106"	52" x 92"	52" x 92"	53 1/4" x 93 1/4"	58 3/8" x 98 3/8"		
110"	54" x 96"	54" x 96"	55 1/4" x 97 1/4"	60 3/8" x 102 3/8"		
119"	58" x 104"	58" x 104"	59 1/4" x 105 1/4"	64 3/8" x 110 3/8"		
133"	65" x 116"	65" x 116"	66 1/4" x 117 1/4"	71 3/8" x 122 3/8"		
161"	79" x 140"	79" x 140"	80 1/4" x 141 1/4"	85 3/8" x 146 3/8"		
2.39:1 SCOPE Format						
Nominal Diagonal	Image Size	Overall H" x W", Borderless Qty.	Overall H" x W", 5/8" Vel-Tex Bezel Qty.	Overall H" x W", 3 3/8" Vel-Tex Bezel Qty.		
90"	35" x 83 1/2"	35" x 83 1/2"	36 1/4" x 84 3/4"	41 3/8" x 89 3/8"		
116"	45" x 107 1/2"	45" x 107 1/2"	46 1/4" x 108 3/4"	51 3/8" x 113 3/8"		
135"	52" x 124"	52" x 124"	53 1/4" x 125 1/4"	58 3/8" x 130 3/8"		
150"	58" x 138 1/2"	58" x 138 1/2"	59 1/4" x 139 3/4"	64 3/8" x 144 3/8"		
21:9 Ultrawide Format						
Nominal Diagonal	Image Size	Overall H" x W", Borderless Qty.	Overall H" x W", 5/8" Vel-Tex Bezel Qty.	Overall H" x W", 3 3/8" Vel-Tex Bezel Qty.		
104 1/4"	40 1/4" x 96"	40 1/4" x 96"	41 1/2" x 97 1/4"	46 3/8" x 102 3/8"		
126"	49" x 116"	49" x 116"	50 1/4" x 117 1/4"	55 3/8" x 122 3/8"		
152"	59" x 140"	59" x 140"	60 1/4" x 141 1/4"	65 3/8" x 146 3/8"		
Custom Size						
Nominal Diagonal	Image Size	Overall H" x W", Borderless	Overall H" x W", 5/8" Vel-Tex Bezel	Overall H" x W", 3 3/8" Vel-Tex Bezel		

#### Please Mark Appropriate Selections.

#### Select Frame Options:

- No Bezel (Borderless)
- 5/8" (16mm) Bezel (Black Vel-Tex textile covering standard)
- 3 3/8" (81mm) Bezel (Black Vel-Tex textile covering standard)

#### Select Viewing Surface:

- TECVISION** Premium Optical Surface

#### Choose TecVision® surface:

- XH700X Grey (0.7 gain) Certified
- XH800X ALR (0.8 gain) Certified
- XH900X ALR (0.9 gain) Certified
- MS1000X ALR (1.0 gain) Certified
- CS1000X ALR (1.0 gain) Certified
- CS1200X ALR (1.2 gain) Certified
- XT1000X White (1.0 gain) Certified
- XT1100X White (1.1 gain) Certified
- XT1300X White (1.3 gain) Certified
- XT1600X White (1.6 gain) Certified
- XT1800X White (1.8 gain) Certified
- Other

- If ordering Tecvision® with perforated material (if NanoPerf is specified, subframe is painted black.)

#### Choose standard viewing surface:

- Matt White XT1000VB\* (1.0 gain): GREENGUARD Gold certified
- Grey XH600V (0.6 gain) (Thru 9' x 12'): GREENGUARD Gold certified
- Clearsound Nanoperf XT1000V (1.0 gain)
- Other



Draper, Inc. | 411 S. Pearl St. Spiceland, IN 47385  
draperinc.com | 765.987.7999 | 800.238.7999

© 2024 All Rights Reserved | FORM: StyleLine\_Sub24

PROJECT: \_\_\_\_\_

ARCHITECT: \_\_\_\_\_

CONTRACTOR: \_\_\_\_\_

SUPPLIER: \_\_\_\_\_

DATE: \_\_\_\_\_ REVISED: \_\_\_\_\_

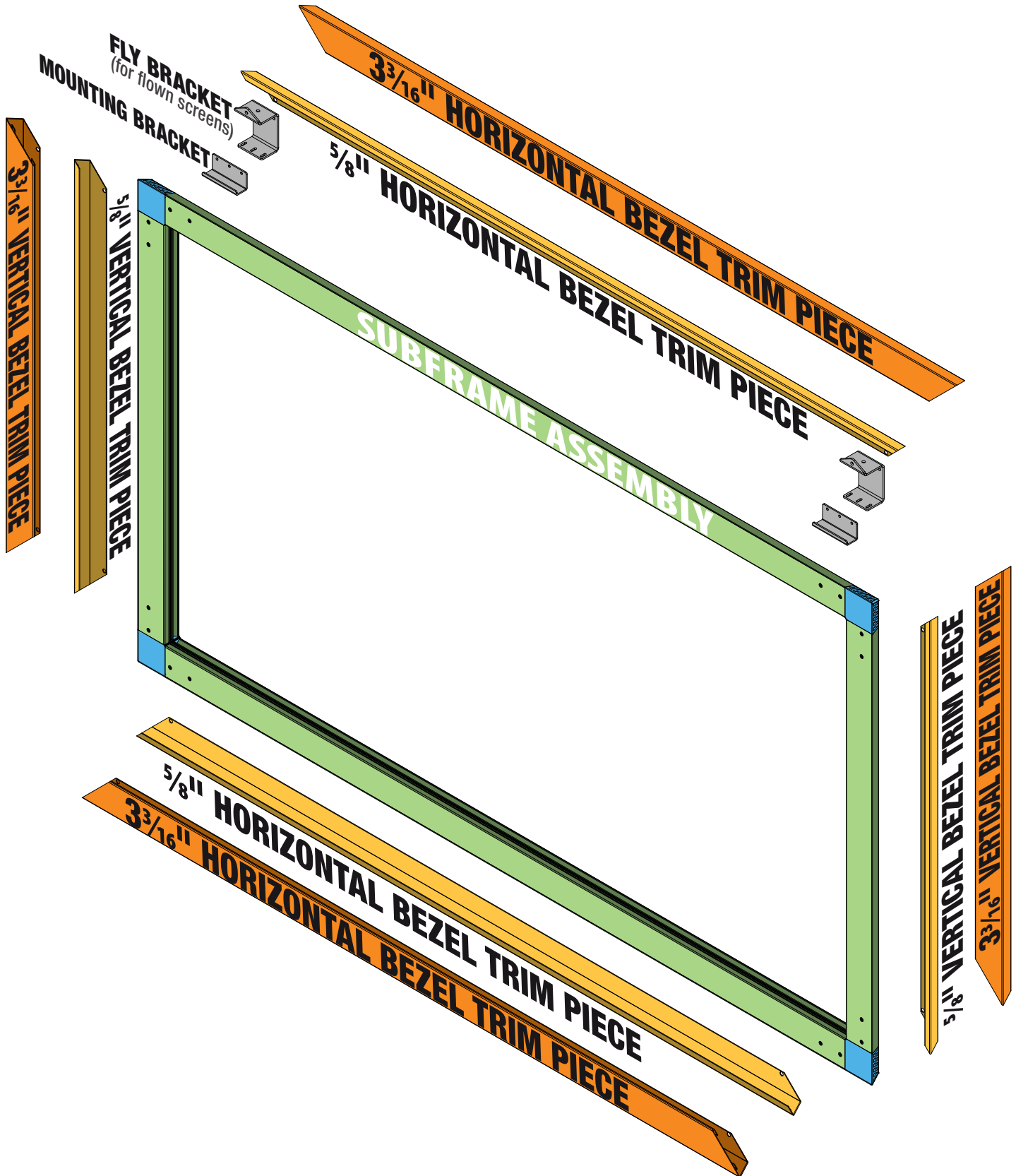

## Dimensions

### $\frac{5}{8}$ " (16mm) BEZEL STYLELINE

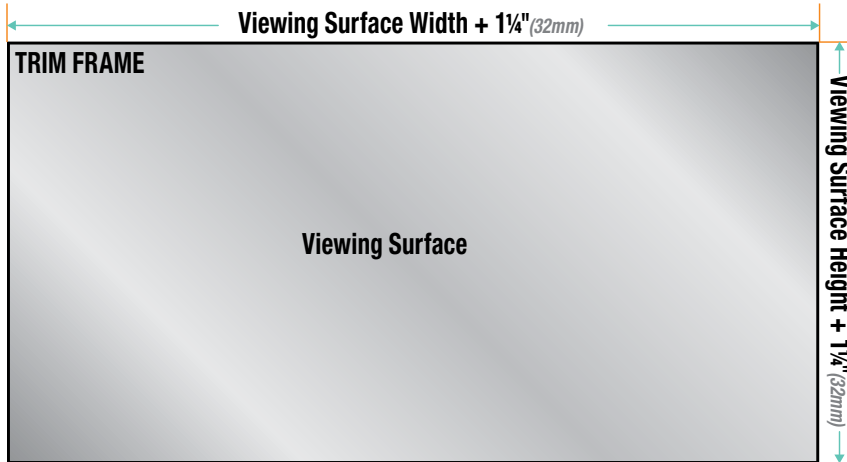

### $\frac{5}{8}$ " BEZEL WALL MOUNT

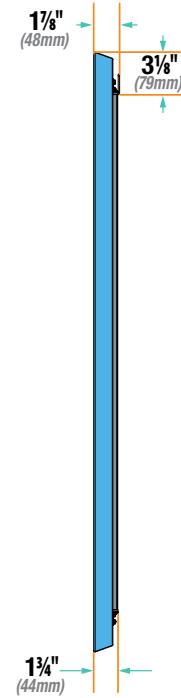

### $\frac{5}{8}$ " BEZEL FLOWN

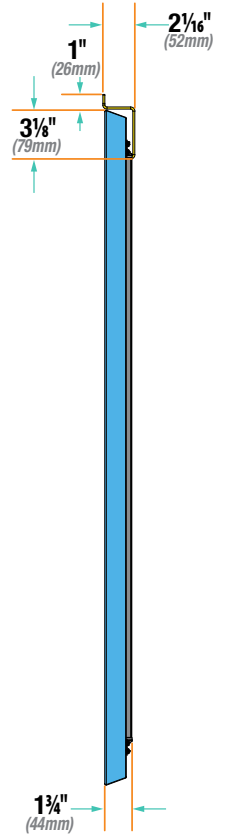

### $3\frac{3}{16}$ " (81mm) BEZEL STYLELINE

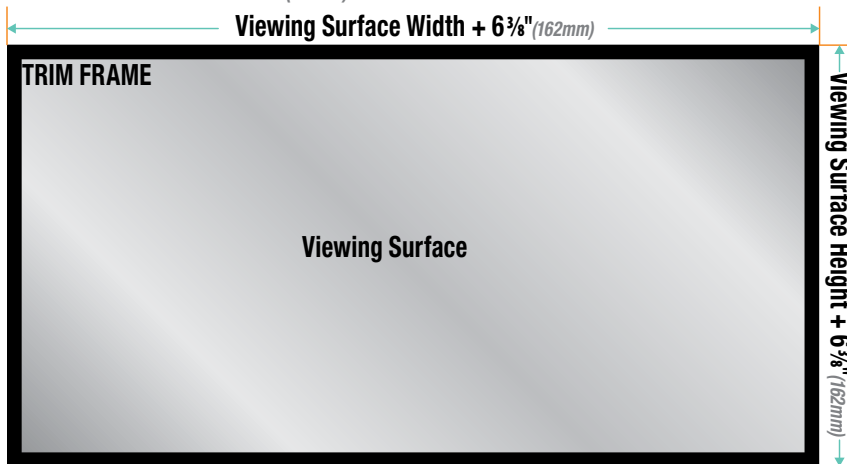

### $3\frac{3}{16}$ " BEZEL WALL MOUNT

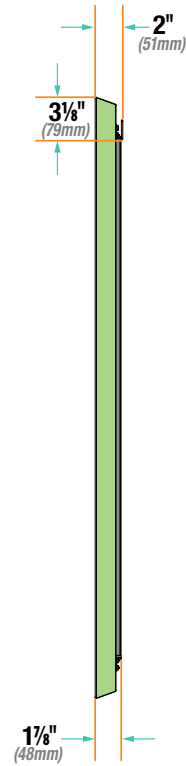

### $3\frac{3}{16}$ " BEZEL FLOWN

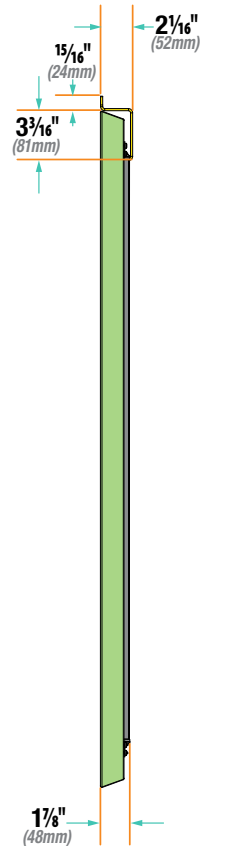

Dimensions (continued)

## BORDERLESS STYLELINE

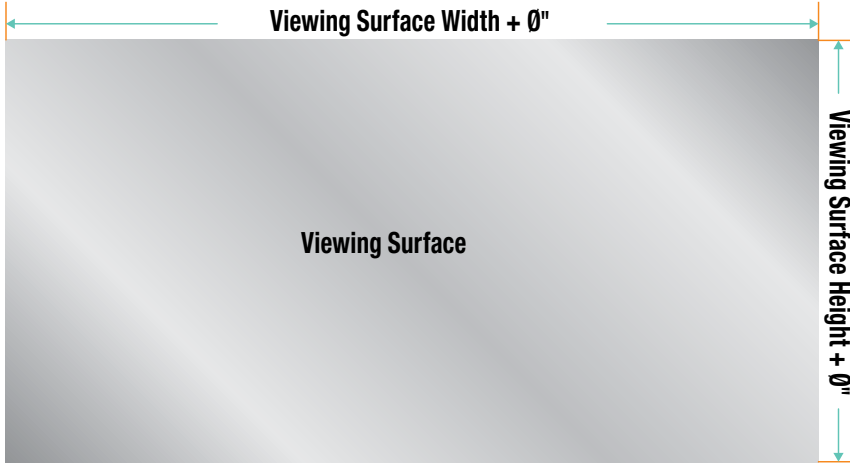

## BORDERLESS WALL MOUNT

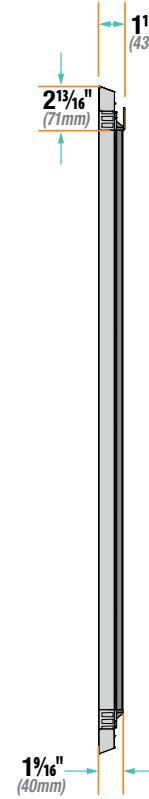

## BORDERLESS FLOWN

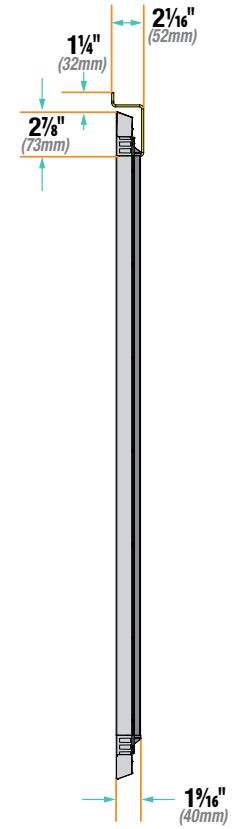

Mounting Bracket Dimensions

### Wall Mounting Bracket

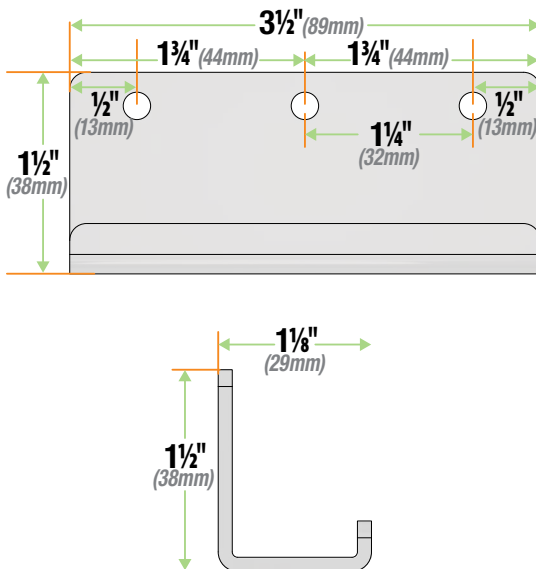

### Mounting Bracket for flown screens

